

POS Arm 200

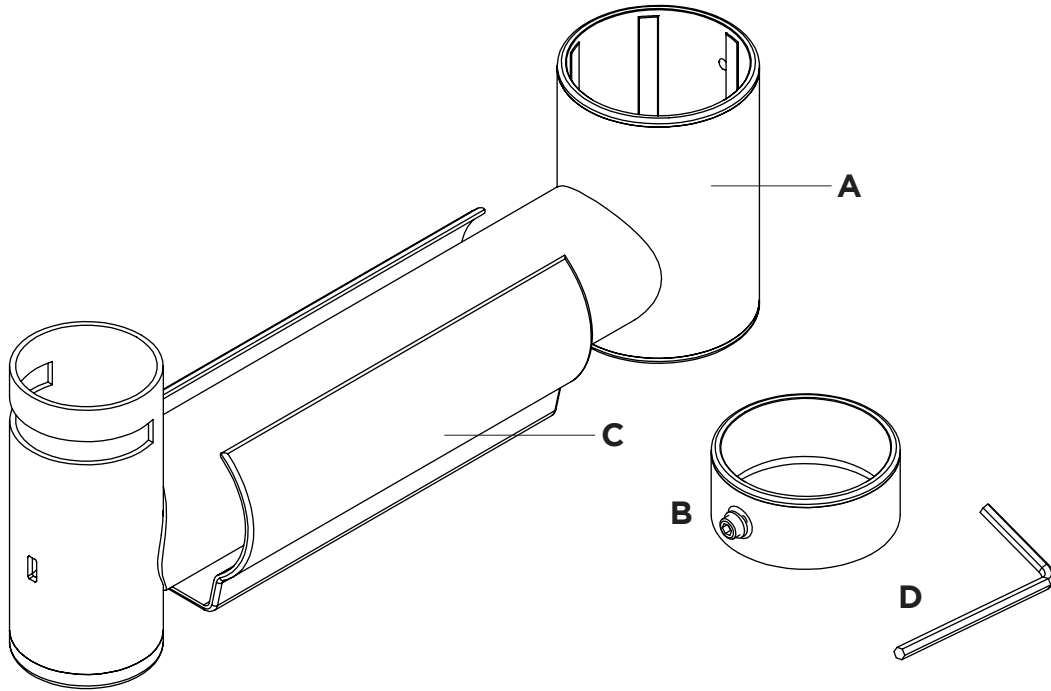

COMPONENT CHECKLIST

Item	Name	QTY
A	Arm 200mm	1
B	Fixing Ring	1
C	Cable Clip 40mm	1
D	3mm Allen Key	1